

# Data Sheet

## FUJITSU Mainboard D3434-S Mini-ITX

### Industrial Series

Powered by the Intel® H110 Express Chipset supporting DDR4 2133/2400 SDRAM Memory and 6<sup>th</sup> & 7<sup>th</sup> generation Intel® Core™ i3 / i5 / i7 Processors (Socket LGA1151)  
Designed & approved for enhanced operating temperature range from 0°C to 60°C  
Designed & approved for 24/7 continuous operation



#### Chipset:

Intel® H110 Express Chipset

#### Processors:

Intel® Core™ i7 / i5 / i3 – (6<sup>th</sup> & 7<sup>th</sup> gen.) processor series  
Intel® Pentium® / Intel® Celeron® (6<sup>th</sup> & 7<sup>th</sup> gen.) processor series  
Socket LGA1151 – up to 65W TDP

#### Memory:

DDR4 2133 SDRAM (SO-UDIMM)  
DDR4 2400 SDRAM (SO-UDIMM)

#### Product Features:

Intel® HD Graphics (integrated in processor e.g. HD510/530)  
DVI-D, DP V1.2, eDP and Dual Channel LVDS support  
PCI Express x16 Gen3 and Mini-PCI Express onboard  
8 Bit GPIO & multichannel Audio onboard  
Onboard support for M.2 SSD (SATA-based M.2)  
USB 2.0 and USB3.0 onboard  
2 x Intel GbE LAN onboard (incl. teaming support)  
Intel integrated TPM V2.0 onboard

Dual Power Supply (ATX compliant & 12V only)  
BIOS-POST/-Boot & OS – HW Watchdog onboard

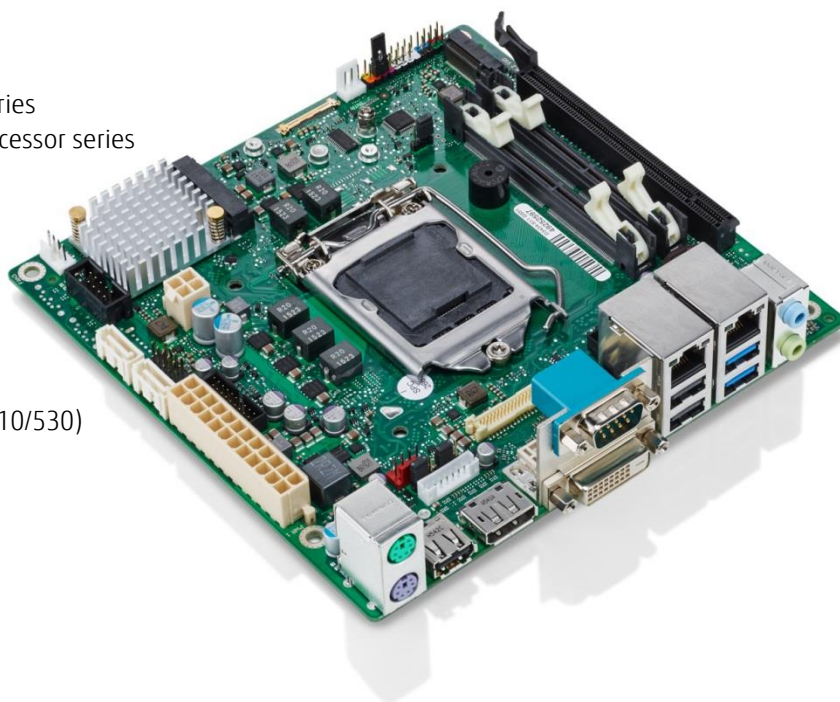

# Features and benefits

<b>Board Size</b>	Mini-ITX: 6.7" x 6.7" (170 x 170 mm)
<b>Chipset</b>	Intel® H110 Express Chipset
<b>Memory</b>	2 x SO-DIMM Socket (1.2V), max. 32GB, Dual Channel, DDR4 - 2133 (CL15) / - 2400 (CL17) SDRAM, unbuffered, non-ECC Effective memory speed depends on installed processor
<b>Processor</b>	Intel® Core™ i7 / i5 / i3 - (6 <sup>th</sup> generation) processor series Intel® Core™ i7 / i5 / i3 - (7 <sup>th</sup> generation) processor series (D3434-S2 only) Intel® Pentium® / Intel Celeron® processor series Socket LGA1151, max. 65W TDP (For details on supported processors please refer to OEM FTP Server)
<b>Power Specification</b>	ATX- 24 Pin / ATX- 20 Pin or 12V only Power Supply required; Support for Soft-Off Power Supplies; 3.3V Auxiliary Supply Voltage on PCIe Slot (Wake-Up Function)
<b>Power Supply Requirements</b>	for onboard components (worst case incl. processor & memory; w/o USB devices; w/o PCIe cards, w/o M.2, w/o SATA drives)

Source <sup>1)</sup>	Voltage	Min. PS Load	Max.Voltage Tolerance	Mainboard Capacitive Load	Max. Mainboard Current
ATX Power Supply	+ 12V	0.05A	± 5 %	1.300µF	8A/12A <sup>2)</sup>
	- 12V	0A		--	not used
	+ 5V	0.2A	± 5 %	900µF	3A
	+ 3.3V	0A	± 5 %	350µF	0.5A
	+ 5Vaux	0A	+5 % / -3%	330µF	0.5A
12V only PSU	+12V	0A	± 5 %	1.300µF	8A/12A <sup>2)</sup>

1) ATX PSU or 12V only DC Supply

2) Max. Cont. Current = 8A; max. Surge Current = 10A (< 100sec) / 12A (< 10ms)

<b>BIOS</b>	AMI Aptio 5.x (UEFI) BIOS modified and adapted by Fujitsu Technology Solutions; Recovery BIOS, SM-BIOS (DMI), BIOS and CPU Microcode Update, Quick Boot, Logo Boot, Quiet Boot, Plug & Play, Automatic DRAM and PCIe Configuration, BIOS Support for S.M.A.R.T., Advanced Power Management, ACPI S3/S4, Wake on time from S5. Boot support for M.2 SSD (SATA-based M.2, AHCI / NVME) BIOS integrated HW Diagnostic Tool, Watchdog Support
-------------	--

<b>Security Features</b>	Recovery BIOS, System and BIOS Password, Boot Sequence Control, Serial- / USB- Port Access Protection, Boot Sector Virus Warning, Write Protection for Flash BIOS, EraseDisk (BIOS Feature), Intel integrated TPM V2.0
--------------------------	--

<b>Special Features</b>	Silent Fan	Independent temperature related processor fan and system fan supervision and control	
	System Guard	View and adjust Silent Fan features	
	Silent Drives	Noise reduction for optical and hard disk drives	
	Recovery BIOS	Restores a corrupted BIOS	
	Desk Update	Simple driver update with Driver & Utilities DVD	
	Multi Boot	Comfortable boot from any boot device	
	HDD Password	Access protection for disk drives	
	Always On	Reliable power-on whenever voltage is connected	
	Never Off	Option to prevent the system from being shut down	
	CSA / UL / FCC certified	cCSAus 60950-1/ FCC-B (planned)	

<b>Operating Systems</b>	<b>OS</b>	<b>"Runnable"</b>	<b>"Tested/Released by Fujitsu"</b>
	MS Windows XP	--	--
	MS Windows 7-32 <sup>1)</sup>	X	X
	MS Windows 7-64 <sup>1)</sup>	X	X
	MS Windows 8.1-64 <sup>1)</sup>	X	X (-S1 only)
	MS Windows 10-64	X	X
	Linux-32	X	--
	Linux-64	X	--

1) Requires only Skylake (= 6<sup>th</sup> gen.) processor! Kabylake (=7<sup>th</sup> gen.) processor supports only Windows 10

**Further Features**

Feature	Mainboard Versions	
	D3434-S1x	D3434-S2x
SO-DIMM DDR4-2133 / DDR4-2400	x / - <sup>1)</sup>	x / x
Intel® Core™ i processor series – 6 <sup>th</sup> gen. / 7 <sup>th</sup> gen.	x / -	x / x
Intel® Pentium® / Celeron® processor series – 6 <sup>th</sup> gen. / 7 <sup>th</sup> gen.	x / -	x / x

1) DDR4-2400 modules can be used, but they will operate at reduced speed

<b>Designed for Industrial Applications</b>	Longlife components	Designed for 24/7 use in industrial applications
	Revision control	Strict control and pre-announcement
	Extended lifecycle	Mainboard available for more than four years
	Industrial grade EMI immunity	
	Enhanced operating temperature range (0°C-60°C) <sup>1</sup>	

<b>Graphics</b>	Intel® HD Graphics, DX12, Embedded Display Port (2 lanes supported) DVI-D, 1 x DisplayPort V1.2, Dual-Channel 24bit LVDS (max. 2 indep. displays)
-----------------	--

<b>Audio</b>	Realtek ALC671, 5.1-channel, High Definition Audio Codec
--------------	--

<b>LAN</b>	Intel i219LM & i210AT with 10/100/1000 MBit/s, Wake-on-LAN (WoL) by interesting Packets, Link Status Change and Magic Packet™, PXE Support, BIOS MAC Address Display, Teaming Support
------------	---

<b>Drives</b>	2 Serial ATA III 600 Interface (up to 6Gbit/s), NCQ, AHCI; 1 x M.2 Socket (2242/2260) for SATA based M.2 modules, AHCI Boot support
---------------	--

<sup>1</sup> Forced cooling required, see technical documentation for detailed requirements

<b>Features</b> <b>D3434-S</b>	Chipset	iH110
	Board Size	Mini-ITX
	VGA / DVI-I / DVI-D / DP V1.2 / 2 <sup>nd</sup> DP V1.2 / LVDS / eDP	- / - / ✓ / ✓ / ✓ / - / ✓ / ✓ / ✓
	Buzzer / int. Speaker Support / 5.1 Multichannel Audio	✓ / ✓ / ✓
	Dual LAN Gbit / 100 Mbit / 10 Mbit / WoL / LAN Boot	✓ / ✓ / ✓ / ✓ / ✓ / ✓
	iAMT 11.0 vPro / Intel Standard Manageability / DASH V1.1	- / - / -
	SATA / ATA / RAID / eSATA-Support / mSATA / M.2 SSD	✓ / - / - / ✓ / ✓ / - / ✓
	FireWire™ / USB 2.0 / USB 3.0	- / ✓ / ✓
	FAN monitored & controlled PSU / CPU / AUX1 <sup>2</sup> / AUX2	- / ✓ / ✓ / ✓ / -
	TEMP monitored CPU / onboard sensors / external sensor	✓ / ✓ / ✓ / -
<b>Special Features</b> <b>D3434-S</b>	Silent Fan / Silent Fan LT / System Guard / Silent Drives	✓ / - / ✓ / ✓ / ✓
	Recovery BIOS / Desk Update / Multi Boot	✓ / ✓ / ✓ / ✓
	HDD Password / HDD Encryption / EraseDisk / TPM	✓ / - / ✓ / ✓ / ✓
	Logo Boot Option / Intel On Screen Branding	✓ / ✓
	High Efficiency Core Voltage Regulator Design	✓
	BIOS POST- / BIOS Boot- / OS- HW Watchdog	✓ / ✓ / ✓ / ✓
	Operating Mode 24-7 / 8-5 (hrs per day - days per week)	✓ / -
	Mainboard operating temperature range (chassis inside) <sup>3</sup>	0°C – 60°C
	<b>Internal Connectors</b> <b>D3434-S</b>	SO DIMM Sockets (DDR4 2133)
PCI Express x16 (Gen3) / Support for lane split (8+8 or 8+4+4)		1 / -
mSATA / Mini PCI Express Slot (halfsize / fullsize, incl.USB 2.0)		- / 1
SATA-600 / SATA-300 / mSATA / M.2 SSD <sup>4</sup>		2 / - / - / 1
S/PDIF (digital Audio) OUT / IN		1 / 0
Frontpanel Audio (9-Pin, HD Audio & Legacy Audio AC97)		1
USB 2.0 channels / USB 3.0 channels / USB Stick (3.0)		2 / 2 / -
Serial (COM2, RS232) / Parallel Port Connector		1 / -
LVDS / LVDS Backlight / Embedded DisplayPort		1 / 1 / 1
FAN PSU / CPU / AUX1 <sup>2</sup> / AUX2		0 / 1 / 1 / 0
Intrusion (Case Open) / GPIO <sup>5</sup> (8Bit) / SMBus (Case Temp.)		1 / 1 / -
ATX Power Supply (24 pin + 4 pin) / 12V-only PSU <sup>5</sup>		1 / 1
<b>External Connectors</b> <b>D3434-S</b>		VGA Sub D / DVI-I / DVI-D / DisplayPort V1.2
	Audio Mic. In / Line in / Line out (or driver configuration)	- / 1 / 1
	LAN (RJ-45)	2
	PS/2 Mouse / Keyboard	1 / 1
	USB 2.0 / USB 3.0	3 / 2
	Serial (COM1, RS232)	1

<sup>2</sup> Fan AUX1 = 3Pin & PWM support

<sup>3</sup> Forced cooling required, see technical documentation for detailed requirements

<sup>4</sup> If a M.2 module @60mm is installed, only halfsize Mini-PCIe module can be installed!

D3434-S supports M.2 SATA-based modules only!

<sup>5</sup> Alternative: Powered by 12V DC only. See TechNotes document for further details

External Connectors

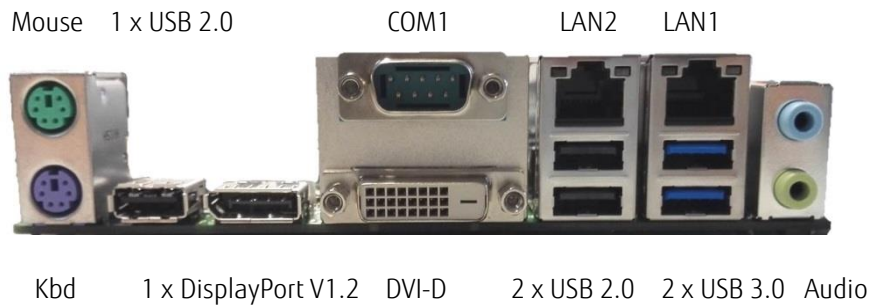



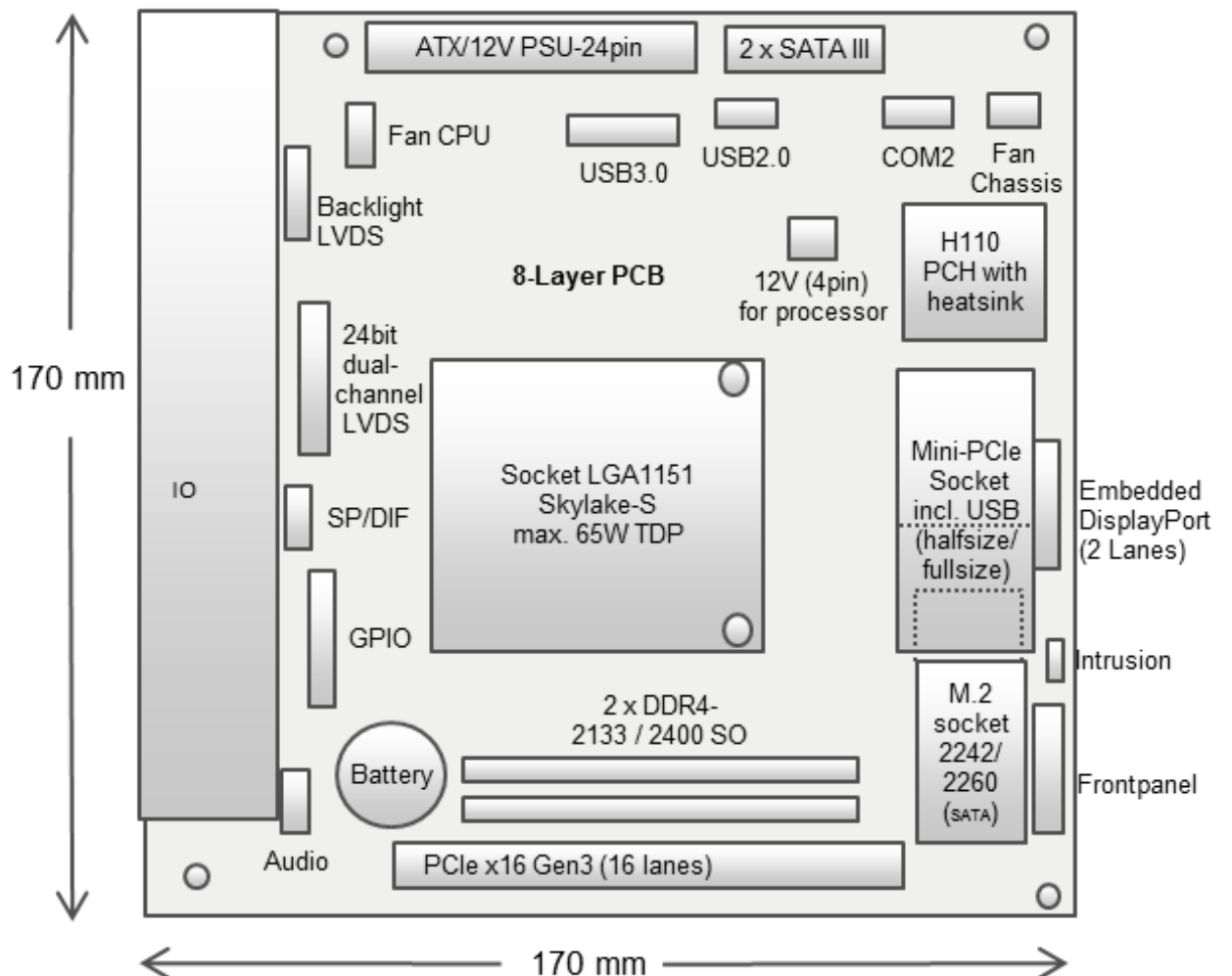

Connector / Socket Diagram



---

## Accessories

Mini PCIe to M.2 Adapter	D3436-S		
Serial Port Cable "ATX Slotbracket		S26361-F5000-K005	
Risercard 1x PCIe X4	D3318-A	S26361-F5000-R006	
M.2 Carrier Board	D3352-A2	S26361-F5000-M002	

---

## Further industrial products offered by Fujitsu

- Connectors
- KVM Switches
- Relays
- Touch Panels
- Thermal Printers
- Wireless Modules



24 Volt Kiosk Printers



Multi-Input Touch Panels

## Contact:

Fujitsu Components Europe, B.V.  
Tel.: +31 (0)23 556 0910  
Fax: +31 (0)23 556 0950  
Website: [emea.fujitsu.com/components](http://emea.fujitsu.com/components)  
Address: Diamantlaan 25  
2132 WV Hoofddorp  
Netherlands

# More information

## Fujitsu products, solutions & services

### Products

[www.fujitsu.com/global/products/](http://www.fujitsu.com/global/products/)

In addition to the Fujitsu mainboards, Fujitsu offers a full portfolio of other computing products.

### Computing products

- Storage systems: ETERNUS
- Server: PRIMERGY, PRIMEQUEST, Fujitsu SPARC M10, BS2000/OSD Mainframe
- Client Computing Devices: LIFEBOOK, STYLISTIC, ESPRIMO, FUTRO, CELSIUS
- Peripherals: Fujitsu Displays, Accessories
- Software
- Network

Product Support Services with different service levels agreements are recommended to safeguard each product and ensure smooth IT operation.

### Solutions

<http://www.fujitsu.com/global/solutions>

The Fujitsu solutions combine reliable Fujitsu products with the best in services, know-how and worldwide partnerships. Fujitsu's Solutions include parts of one or more activity groups (e.g., planning, implementation, support, management, and training services) and are designed to solve a specific business need.

**Infrastructure Solutions** are customer offerings created by bringing Fujitsu's best products, services and technologies together with those from partners to deliver benefit to our customers' businesses.

**Industry Solutions** are tailored to meet the needs of specific verticals.

**Business and Technology Solutions** provide a variety of technologies developed to tackle specific business issues such as security and sustainability, across many verticals.

### Services

[www.fujitsu.com/global/services/](http://www.fujitsu.com/global/services/)

Several customizable Fujitsu Service offerings ensure that IT makes a real difference and delivers true business value. We do this by leveraging our extensive experience in managing large, complex, transformational IT programs to help clients in planning, delivering and operating IT services in a challenging and changing business environment.

**Application Services** support the development, integration, testing, deployment and on-going management of both custom developed and packaged applications. The services focus on delivering business and productivity improvements for organizations.

**Business Services** respond to the challenge of planning, delivering and operating IT in a complex and changing IT environment.

**Managed Infrastructure Services** enable customers to deliver the optimal IT environment to meet their needs – achieving high levels of IT service quality and performance for data center and end user environments.

## Fujitsu green policy innovation

[www.fujitsu.com/global/about/environment/](http://www.fujitsu.com/global/about/environment/)

Fujitsu Green Policy Innovation is our worldwide project for reducing burdens on the environment. Using our global know-how, we aim to resolve issues of environmental energy efficiency through IT. Please find further information at:



## More information

Learn more about Fujitsu, please contact your Fujitsu sales representative, Fujitsu business partner, or visit our website.  
[www.fujitsu.com/fts/mainboards/](http://www.fujitsu.com/fts/mainboards/)

## Copyright

© 2015 Fujitsu Technology Solutions GmbH  
Fujitsu and the Fujitsu logo are trademarks or registered trademarks of Fujitsu Limited in Japan and other countries.

Intel Chipset C236, Xeon C3 and Intel Core i7 / i5 / i3 are trademarks or registered trademarks of Intel Corporation in America and other countries. Other company, product and service names may be trademarks or registered trademarks of their respective owners. All rights reserved, including intellectual property rights. Changes to technical data reserved. Delivery subject to availability. Any liability that the data and illustrations are complete, actual or correct is excluded.

## Disclaimer

Technical data subject to modification and delivery subject to availability. Any liability that the data and illustrations are complete, actual or correct is excluded. Designations may be trademarks and/or copyrights of the respective manufacturer, the use of which by third parties for their own purposes may infringe the rights of such owner.

## Contact

Fujitsu Technology Solutions GmbH  
OEM Mainboard Sales  
Email: [oem-sales@ts.fujitsu.com](mailto:oem-sales@ts.fujitsu.com)

Website: <http://ts.fujitsu.com>  
2017-09-06

Copyright © Fujitsu Technology Solutions

All rights reserved, including intellectual property rights. Changes to technical data reserved. Delivery subject to availability. Any liability that the data and illustrations are complete, actual or correct is excluded. Designations may be trademarks and/or copyrights of the respective manufacturer, the use of which by third parties for their own purposes may infringe the rights of such owner.

For further information see [http://ts.fujitsu.com/terms\\_of\\_use.html](http://ts.fujitsu.com/terms_of_use.html)